

1 Male an:    

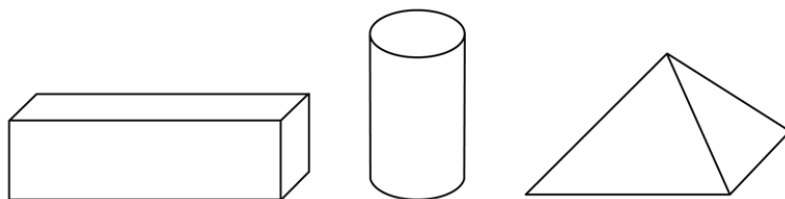

2 Markiere alle Ecken rot.

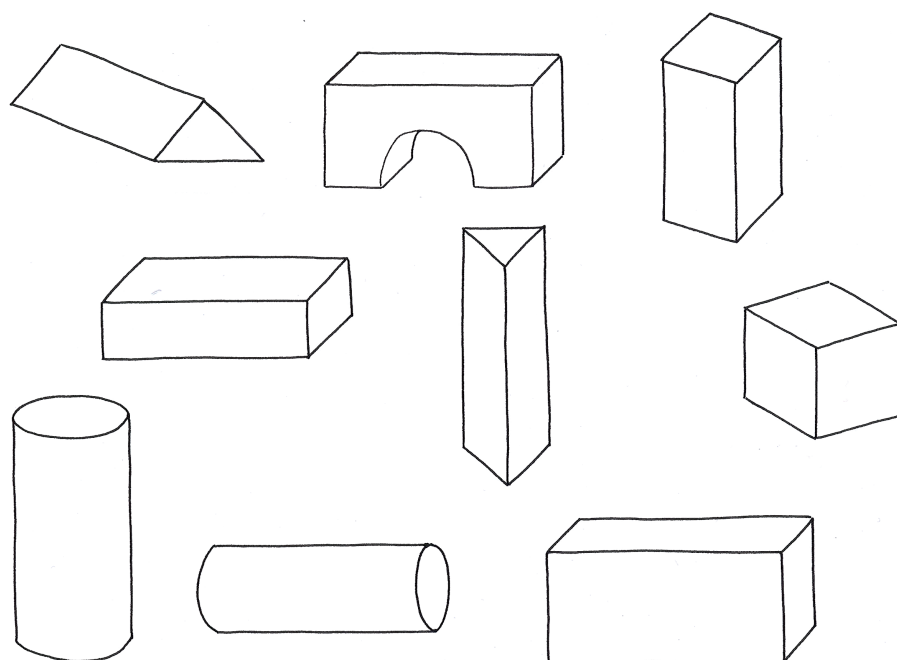

3 Male alle runden Körper blau an.

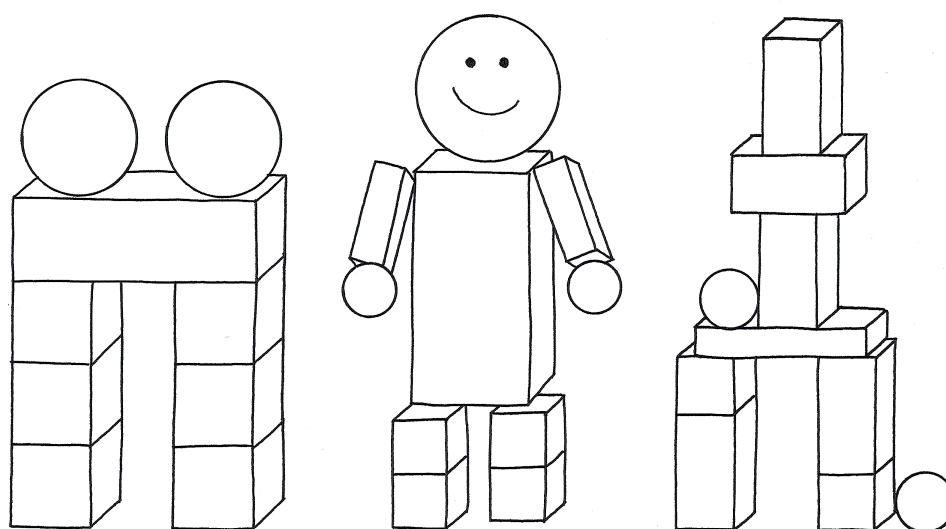

Förderblatt

Arbeiten mit Ebenen und Raum

Körper und Flächen

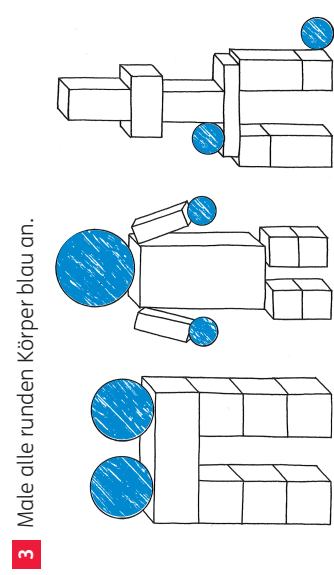
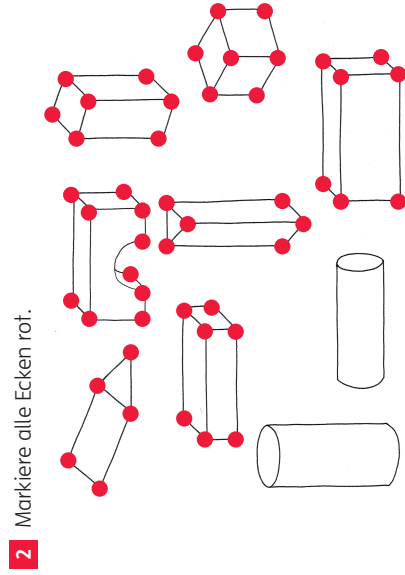
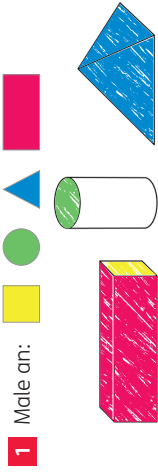

© Österreichischer Bundesverlag Schulbuch GmbH & Co. KG, Wien 2014. Alle Rechte vorbehalten.
Testen und Fördern: MiniMax 1

Förderblatt

Arbeiten mit Ebenen und Raum

Beziehungen zwischen geometrischen Figuren

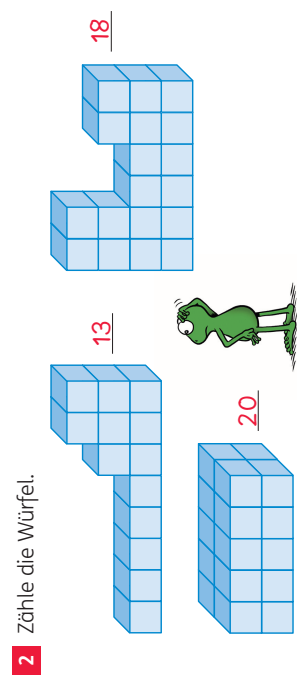
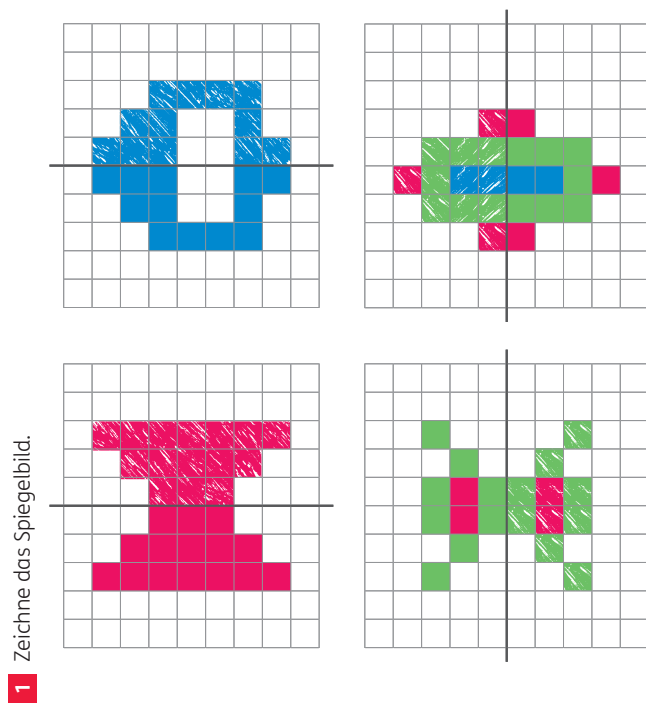

© Österreichischer Bundesverlag Schulbuch GmbH & Co. KG, Wien 2014. Alle Rechte vorbehalten.
Testen und Fördern: MiniMax 1